

T21 LED RECHARGABLE WORK LIGHT 48 Watt





- ROHS
- PF ≥0.9
- CRI ≥80
- Omni
- IP44
- 2 years warranty
- LED PHILIPS 2835
- IES
- UL US LISTED (LUMINAIRE)



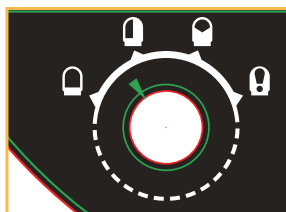
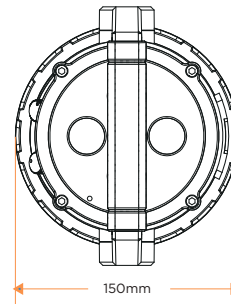
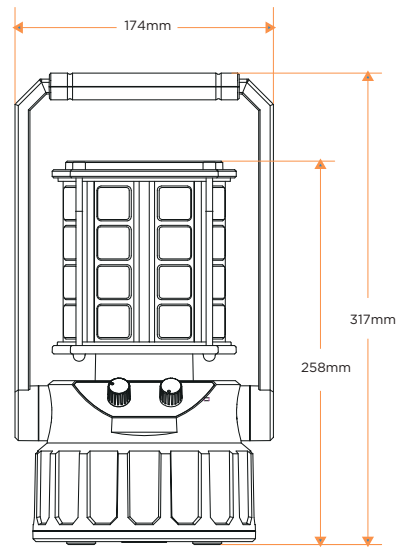

Specification

Model No.	T21 - 01 - 48W
Power	48W +/- 10%
LED Chip	Philips 2835
CCT	3000-5700K
CRI	>80
Lumen	Mode 1: 4000lm +/- 10% Mode 2: 2000lm +/- 10% Mode 3: 800lm +/- 10%
Voltage	100-240VAC 50/60Hz
Size mm	174 x 317mm
Operation temp.	-10C to 40C
Certification	FCC CE CUL UL ROHS
Battery capacity	14.8V/7800mAh
USB output	5V/2A
Warranty	Light: 2 Years, Battery: 1 Year
Recommended charge time	8 Hours
IP Level	IP 44



 360° light on the sides of the device, no light on the top

 180° light on the side of the device, no light on the top

 Light on the top of the device, no light on the sides

 Light on the top of the device, flashing once every 0.4 seconds, no light on the sides



Dimming switch. Min is off, max is 100%

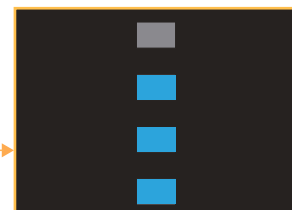

Battery indicator, 25% per block

Light distribution curve of indoor light

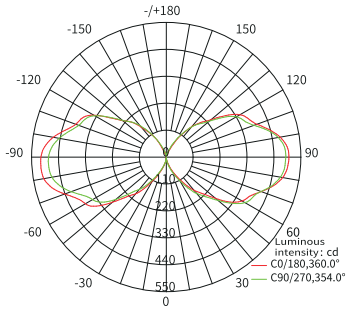

Luminous output
221.0 lm

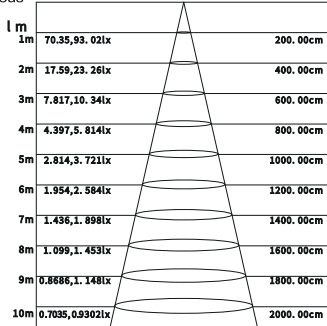

T21- "360" mode

CCT	5000K
Rated supply voltage (V)	100V-240V
Measured power supply voltage (V)	230V
Total lumen (lm)	3978lm

Light distribution curve of indoor light

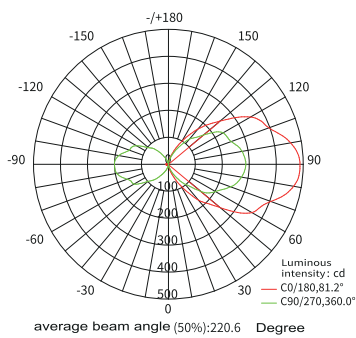

Luminous output
125.2 lm

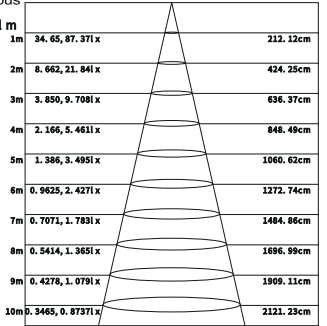

T21- "180" mode

CCT	5000K
Rated supply voltage (V)	100V-240V
Measured power supply voltage (V)	230V
Total lumen (lm)	2038lm

Light distribution curve of indoor light

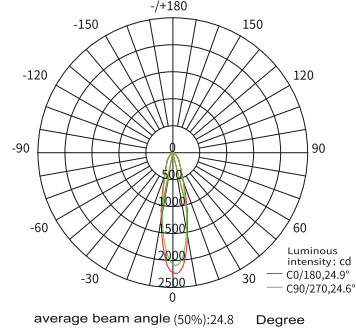

Luminous output
212.4 lm

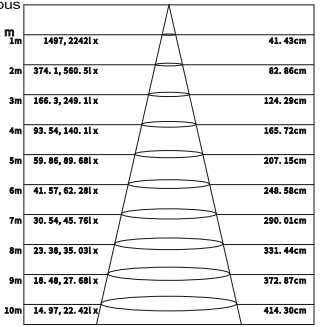

T21- "Spotlight" mode

CCT	5000K
Rated supply voltage (V)	100V-240V
Measured power supply voltage (V)	230V
Total lumen (lm)	849lm



Applications





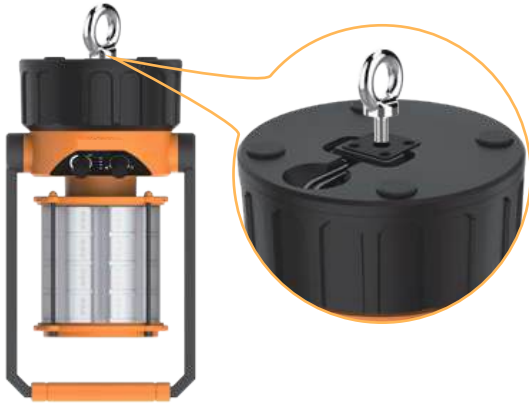

Hanging



Hanging with eyebolt
(Optional extra)



Tripod
(Optional extra)

Battery Life		
Mode	Power	7800mAh Battery Life
 Mode 1	4-48W	24H - 2.7H
 Mode 2	4-26W	24H - 5.4H
 Mode 3	5-15W	18H - 8.5H
 Mode 4	5-15W	33H - 15H

Packing Info

Model	Inner Dimensions	Carton Dimensions	G.W. Light	G.W. Carton	QTY per Carton
T21 - 01 - 48W	375mm x 200mm x 215mm	418mm x 382mm x 440mm	2.35 KG	13.5 KG	4

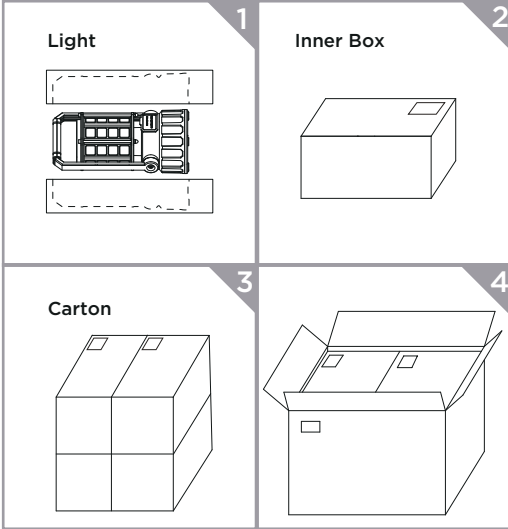

WARNING

- * PLEASE READ ALL INTRUCTIONS BEFORE USE *
- * DO NOT TAMPER WITH LIGHT HOUSINGS
- * DO NOT SUBMERGE IN WATER *
- * PRODUCT WILL HEAT UP AFTER PROLONGED USE *



www.whisafeguard.com